

**DESCRIPTION: COMPRESSOR
(Fire brigades vehicles Austria)**

DESCRIZIONE: COMPRESSORE (Pompieri Austria)

MC4/FA+LUBRICATOR

Cod. 921118 (12V) 921119 (24V)

Main specifications and performances / Principali caratteristiche

Nominal voltage / Voltaggio nominale	12	24	Vdc
Voltage range / Voltaggio di utilizzo	11,5-13,8	23-27,6	Vdc
Current consumption / Assorbimento	17	8	A
Produced pressure / Pressione prodotta	> 1		bar
Cycles per minute / Cicli al minuto	17		cycles
Operating temperature / Temp. di utilizzo	-30° to +60°		°C
Storage temperature / Temp. stoccaggio	-30° to +80°		°C
Corrosion resistance / Resist. alla corrosione	> 96 (salt spray test)		Hours
Operating relative humidity / Umidità di esercizio	30 to 80		%
Continuous blowing with oliator	> 30		min
Continuous blowing without oliator	10		min
Electrical insulation / Isolamento elettrico	1000		Vdc
Vibration (30 min, 3 axis) / Vibrazioni	1		g
Weight / Peso	1200 + 247		gr
Main materials / Principali materiali	Steel, Aluminum, Glass		
Main applications / Principali applicazioni	Cars, Van, Trucks		

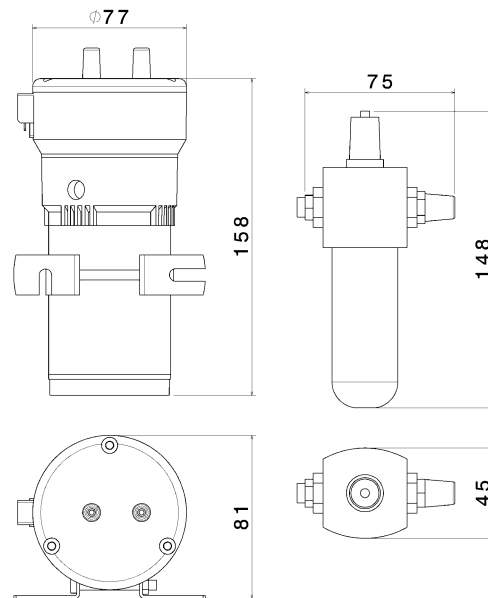
Dimensions (mm) / Dimensioni (mm)

Available Electrical Connection / Connessioni elettriche disponibili

Two terminals 6,3x0,8mm / 2 spine 6,3x0,8mm

Other specifications / Ulteriori specifiche

Installation: Mount the component on a flat and rigid surface in a ventilated position. The component must be away from direct or indirect heat sources and protect from jets of water and mood

Installazione: Montare il compressore su una superficie piana e rigida in posizione ventilata. Il compressore deve essere posto lontano da fonti dirette o indirette di calore e protetto da getti d'acqua e di fango.

Packaging: Box 113x194x80 mm

Imballo: Scatola cartone 113x194x80 mm

Master carton: 16 pieces

Imballo multiplo: cartone da 16 pezzi

Conformity to Standards of / Conformità agli Standards

PRODUCT ✓ REG. 10 ECE
PRODOTTO

MANUFACTURING ✓ ISO/TS 16949
PRODUZIONE ✓ ISO 9001
 ✓ ISO 14001

Product and packaging / Prodotto e confezione
