

DESCRIPTION: AIR POWERED HORN

DESCRIZIONE: AVVISATORE PNEUMATICO

FULTONE T

Ref. 920308

Main specifications and performances / Principali caratteristiche

Sound pressure level / Livello sonoro	117 (2m)	dB(A)
Frequency 'L' / Frequenza tono basso	260	Hz
Frequency 'H' / Frequenza tono alto	300	Hz
Working pressure / Pressione di esercizio	500 - 1200	kPa
Air consumption / Consumo d'aria	0,9	l/sec
Operating temperature / Temp. di utilizzo	-30° to +80°	°C
Storage temperature / Temp. stoccaggio	-30° to +80°	°C
Corrosion resistance / Resist. alla corrosione	> 600 (salt spray test)	Hours
Operating relative humidity / Umidità di esercizio	30 to 80	%
Durability (1 sec ON, 4 sec OFF) / Durata	>50 000	Cycles
Continuous blowing	60	min
Vibration (30 min, 3 axis) / Vibrazioni	1	g
Weight / Peso	900	gr
Main Materials / Principali materiali	Stainless Steel, Aluminum	
Main applications / Principali applicazioni	Trucks	

Dimensions (mm) / Dimensioni (mm)

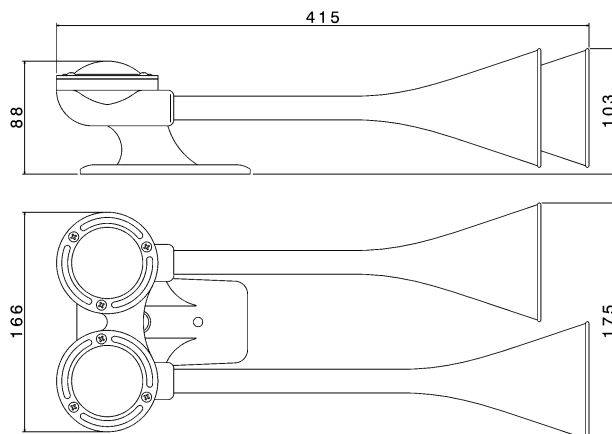

Pneumatic connection / Connessione pneumatica

Threaded hole 1/8 GAS / Foro filettato 1/8 GAS

Other specifications / Ulteriori specifiche

Mechanical connection: flat and rigid surface facing the brackets edge

Montaggio meccanico: fissare la staffa a una superficie piana e rigida.

Horn's Protection: choose an installation area protected from mud splash

Protezione: installare al riparo da spruzzi di fango.

Packaging: Color box 135 x 480 x h200 mm

Imballo: scatola cartone 135x480xh200 mm

Master carton: 6 pieces

Imballo multiplo: cartone da 6 pezzi

Conformity to Standards of / Conformità agli Standard

PRODUCT ✓ CEE 70/388
PRODOTTO ✓ REG. 28 ECE

MANUFACTURING ✓ ISO/TS 16949
PRODUZIONE ✓ ISO 9001
✓ ISO 14001

Product and packaging / Prodotto e confezione

